

Air-to-Water Recirculating Cooler AWC100

for working near ambient temperature

The AWC100 model requires very little space and has a very low procurement cost.

- Plug it in, switch it on, and you're ready to go
- Whisper quiet
- Saves energy (compressor-free design)
- Water loop cooled by fan air
- Uniform pump capacity
- Cooling performance adjustable in two steps
- Filling level indicator

Ambient temperature: +20 °C

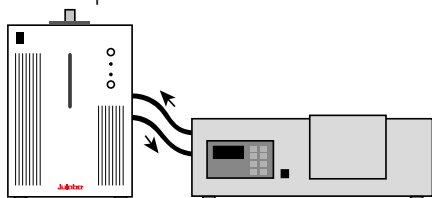

AWC100 is designed to cool water in closed loops. The unit permanently removes heat from water as it flows through the machine.

Applications

Cooling of Peltier elements, particularly for automated analysis units and CCD cameras, polarimeters, refractometers, electrophoresis chambers, condensers for glass apparatus

Example for determining cooling capacity

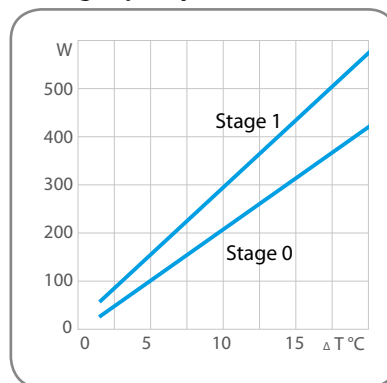

Ambient temperature: +20 °C
 Return temperature: +30 °C
 ΔT: +10 °C
 Cooling capacity (stage 1): 300 W



AWC100

Order No.	9 630 100		
Model	AWC100		
Working temperature range °C ¹⁾	+20 ... +40		
Temperature stability °C	-		
Cooling capacity ¹⁾ W	+20 °C	+10 °C	+5 °C
Stage 0	400	220	120
Stage 1	550	300	180
Pump capacity	l/min	2.9	
Flow rate / Pressure	bar	0.2	
Filling volume liters	0.9		
Dimensions cm	W × L × H 20 × 34 × 30		

1) Cooling capacity depends on the temperature differential between the return flow and ambient environment. Included in delivery: 2 barbed fittings each for tubing 8 and 10 mm ID (pump connections M10x1 female)

Compact Recirculating Coolers

for simple cooling tasks

JULABO F models require very little space and have very low procurement costs.

Recirculating coolers of the F Series are a great way to replace costly tap water and are ideal for basic cooling tasks.

- Environmentally-friendly operation with low energy consumption
- Compact design
- Splash-proof membrane keypad with LED temperature display
- Straightforward filling and draining
- Filling level indicator
- May be used with water, water-glycol, JULABO Thermal G

For cooling of

- Rotary evaporators
- Kjeldahl instruments
- Measuring cells
- Automated analysis systems
- CCD cameras
- Polarimeters, refractometers
- Condensers for glass apparatus
- Calorimeters
- Soxhlet apparatuses

Included in delivery with F250: 2 barbed fittings each for tubing 8 and 10 mm ID (pump connections M10x1 female)
 Included in delivery with F500, F1000: 2 barbed fittings each for tubing 8 and 12 mm ID (pump connections M16x1 male)



F250	
Order No.	9 620 025
Model	F250
Working temperature range °C	-10 ... +40
Temperature stability °C	±0.5
Cooling capacity kW	+20 °C +10 °C +5 °C
	0.25 0.22 0.21
	0 °C -5 °C -10 °C
	0.18 0.09 -
Pump capacity	l/min 15
Flow rate / Pressure	bar 0.35
Filling volume liters	1.7 ... 2.6
Dimensions cm	W × L × H 24 × 40 × 52

F500	
Order No.	9 620 050
Model	F500
Working temperature range °C	0 ... +40
Temperature stability °C	±0.5
Cooling capacity kW	+20 °C +10 °C +5 °C
	0.5 0.4 0.3
	0 °C -5 °C -10 °C
	0.25 - -
Pump capacity	l/min 24
Flow rate / Pressure	bar 0.5
Filling volume liters	5 ... 7.5
Dimensions cm	W × L × H 37.5 × 44 × 59

F1000	
Order No.	9 620 100
Model	F1000
Working temperature range °C	0 ... +40
Temperature stability °C	±0.5
Cooling capacity kW	+20 °C +10 °C +5 °C
	1 0.7 0.55
	0 °C -5 °C -10 °C
	0.35 - -
Pump capacity	l/min 23
Flow rate / Pressure	bar 1
Filling volume liters	7 ... 9.5
Dimensions cm	W × L × H 37.5 × 49 × 64

FL Recirculating Coolers

compact models with up to 1.7 kW of cooling capacity for installation below a lab bench

The compact FL models are suited for a wide variety of cooling tasks. Installation under a lab bench saves valuable space. 2 variants: Air-cooled (FL) and water-cooled (FLW).

- Easy filling from above
- Feed pressure indicator (FL1201 and above) and level indicator (all models)
- Large compensation volume
- Circulating pumps designed for continuous operation
- Permissible return temperature up to +80 °C
- Low liquid level protection with visual and acoustic signals
- May be used with water, water-glycol, Thermal bath fluid
- Overload protection for pump motor and cooling machine

Pump capacity

Bath fluid: water

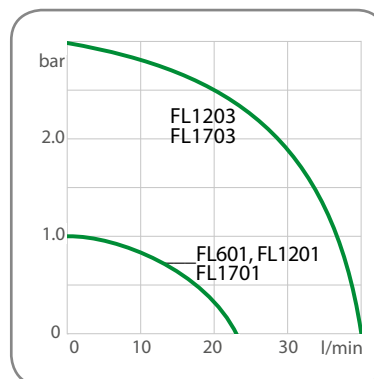

Included in delivery: 2 barbed fittings each for tubing 8 and 12 mm ID (pump connections M16x1 male)
2 barbed fittings for tubing 3/4" ID with models FL1203 and FL(W)1703 (pump connections G 3/4" male)



FL300

Order No.	9 660 003		
Model	FL300		
Working temperature range °C	-20 ... +40		
Temperature stability °C	±0.5		
Cooling capacity kW	+20 °C	+10 °C	0 °C
	0.3	0.25	0.2
	-5 °C	-10 °C	-20 °C
	0.18	0.15	0.1
Pump capacity	l/min	15	
Flow rate / Pressure	bar	0.35	
Filling volume liters	3 ... 4.5		
Dimensions cm	W × L × H 25 × 50 × 60		



FL601

Order No.	9 661 006		
Model	FL601		
Working temperature range °C	-20 ... +40		
Temperature stability °C	±0.5		
Cooling capacity kW	+20 °C	+10 °C	0 °C
	0.6	0.5	0.4
	-5 °C	-10 °C	-20 °C
	0.37	0.33	0.2
Pump capacity	l/min	23	
Flow rate / Pressure	bar	1	
Filling volume liters	5.5 ... 8		
Dimensions cm	W × L × H 32 × 50 × 62		



FL1201

Order No.	9 661 012		
Model	FL1201		
Working temperature range °C	-20 ... +40		
Temperature stability °C	±0.5		
Cooling capacity kW	+20 °C	+10 °C	0 °C
	1.2	1	0.9
	-5 °C	-10 °C	-20 °C
	0.75	0.6	0.3
Pump capacity	l/min	23	
Flow rate / Pressure	bar	1	
Filling volume liters	12 ... 17		
Dimensions cm	W × L × H 50 × 76 × 64		



FLW1701

Order No.	9 671 017		
Model	FLW1701		
Working temperature range °C	-20 ... +40		
Temperature stability °C	±0.5		
Cooling capacity kW	+20 °C	+10 °C	0 °C
	1.7	1.5	1.1
	-5 °C	-10 °C	-20 °C
	0.98	0.85	0.4
Pump capacity	l/min	23	
Flow rate / Pressure	bar	1	
Filling volume liters	12 ... 17		
Dimensions cm	W × L × H 50 × 76 × 64		



FLW1703

Order No.	9 673 017		
Model	FLW1703		
Working temperature range °C	-20 ... +40		
Temperature stability °C	±0.5		
Cooling capacity kW	+20 °C	+10 °C	0 °C
	1.7	1.4	1
	-5 °C	-10 °C	-20 °C
	0.88	0.75	0.3
Pump capacity	l/min	40	
Flow rate / Pressure	bar	0.5 - 3	
Filling volume liters	12 ... 17		
Dimensions cm	W × L × H 50 × 76 × 64		



FL1203

Order No.	9 663 012		
Model	FL1203		
Working temperature range °C	-20 ... +40		
Temperature stability °C	±0.5		
Cooling capacity kW	+20 °C	+10 °C	0 °C
	1.2	0.9	0.8
	-5 °C	-10 °C	-20 °C
	0.65	0.5	0.2
Pump capacity	l/min	40	
Flow rate / Pressure	bar	0.5 - 3	
Filling volume liters	12 ... 17		
Dimensions cm	W × L × H 50 × 76 × 64		



FL1701

Order No.	9 661 017		
Model	FL1701		
Working temperature range °C	-20 ... +40		
Temperature stability °C	±0.5		
Cooling capacity kW	+20 °C	+10 °C	0 °C
	1.7	1.5	1.1
	-5 °C	-10 °C	-20 °C
	0.98	0.85	0.4
Pump capacity	l/min	23	
Flow rate / Pressure	bar	1	
Filling volume liters	12 ... 17		
Dimensions cm	W × L × H 50 × 76 × 64		



FL1703

Order No.	9 663 017		
Model	FL1703		
Working temperature range °C	-20 ... +40		
Temperature stability °C	±0.5		
Cooling capacity kW	+20 °C	+10 °C	0 °C
	1.7	1.4	1
	-5 °C	-10 °C	-20 °C
	0.88	0.75	0.3
Pump capacity	l/min	40	
Flow rate / Pressure	bar	0.5 - 3	
Filling volume liters	12 ... 17		
Dimensions cm	W × L × H 50 × 76 × 64		

FL Recirculating Coolers

powerful models with up to 4.3 kW of cooling capacity, tower version

The FL models shown here have higher cooling capacity, powerful circulating pumps, and internal bath volumes of up to 30 liters. 2 variants: Air-cooled (FL) and water-cooled (FLW).

- Powerful circulating pumps up to 60 l/min; 6 bar
- By-pass valve to adjust pump pressure
- Rollers make it easy to move the units
- Early warning function when condenser is dirty
- Overload protection for pump motor and cooling machine
- Stainless steel bath tank
- BlackBox function with error memory for remote diagnosis
- Stakei connection for connecting a solenoid valve

Applications

Rotary evaporators, bio-reactors/fermenters, Soxhlet apparatuses, distillation systems, vacuum systems, gas chromatographs, spectrometers, semiconductor applications, metering and adhesive technology, diffusion pumps, mass spectrometers, electron microscopes

Filling level indicator

for all models

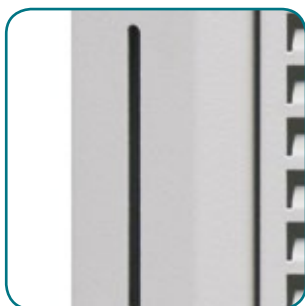

Practical recessed grip



Pump capacity

Bath fluid: water

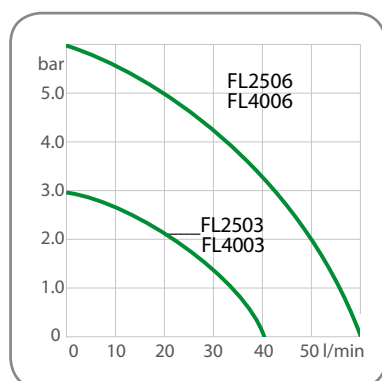

Included in delivery: 2 barbed fittings for tubing 3/4" ID with models FL/FLW2503 and FL/FLW4003 (pump connections G 3/4" male). 2 barbed fittings for tubing 1" ID with models FL/FLW2506 and FL/FLW4006 (pump connections G 1 1/4" male)



FLW2503

Order No.	9 673 025		
Model	FLW2503		
Working temperature range °C	-20 ... +40		
Temperature stability °C	±0.5		
Cooling capacity kW	+20 °C	+10 °C	0 °C
	2.7	2.5	1.7
	-5 °C	-10 °C	-20 °C
	1.35	1	0.4
Pump capacity	l/min	40	
Flow rate / Pressure	bar	0.5 - 3	
Filling volume liters	24 ... 30		
Dimensions cm	W × L × H 60 × 76 × 115		



FL2503

Order No.	9 663 025		
Model	FL2503		
Working temperature range °C	-20 ... +40		
Temperature stability °C	±0.5		
Cooling capacity kW	+20 °C	+10 °C	0 °C
	2.5	2.2	1.5
	-5 °C	-10 °C	-20 °C
	1.35	1.2	0.55
Pump capacity	l/min	40	
Flow rate / Pressure	bar	0.5 - 3	
Filling volume liters	24 ... 30		
Dimensions cm	W × L × H 60 × 76 × 115		



FLW2506

Order No.	9 676 025		
Model	FLW2506		
Working temperature range °C	-15 ... +40		
Temperature stability °C	±0.5		
Cooling capacity kW	+20 °C	+10 °C	0 °C
	2.5	1.9	1
	-5 °C	-10 °C	-20 °C
	0.65	0.3	-
Pump capacity	l/min	60	
Flow rate / Pressure	bar	0.5 - 6	
Filling volume liters	24 ... 30		
Dimensions cm	W × L × H 60 × 76 × 115		



FLW4003

Order No.	9 673 040		
Model	FLW4003		
Working temperature range °C	-20 ... +40		
Temperature stability °C	±0.5		
Cooling capacity kW	+20 °C	+10 °C	0 °C
	4.3	3	2.2
	-5 °C	-10 °C	-20 °C
	1.75	1.3	0.45
Pump capacity	l/min	40	
Flow rate / Pressure	bar	0.5 - 3	
Filling volume liters	24 ... 30		
Dimensions cm	W × L × H 60 × 76 × 115		



FLW4006

Order No.	9 676 040		
Model	FLW4006		
Working temperature range °C	-15 ... +40		
Temperature stability °C	±0.5		
Cooling capacity kW	+20 °C	+10 °C	0 °C
	4	3	1.7
	-5 °C	-10 °C	-20 °C
	1.20	0.7	-
Pump capacity	l/min	60	
Flow rate / Pressure	bar	0.5 - 6	
Filling volume liters	24 ... 30		
Dimensions cm	W × L × H 60 × 76 × 115		



FL2506

Order No.	9 666 025		
Model	FL2506		
Working temperature range °C	-15 ... +40		
Temperature stability °C	±0.5		
Cooling capacity kW	+20 °C	+10 °C	0 °C
	2.5	1.9	1
	-5 °C	-10 °C	-20 °C
	0.65	0.3	-
Pump capacity	l/min	60	
Flow rate / Pressure	bar	0.5 - 6	
Filling volume liters	24 ... 30		
Dimensions cm	W × L × H 60 × 76 × 115		



FL4003

Order No.	9 663 040		
Model	FL4003		
Working temperature range °C	-20 ... +40		
Temperature stability °C	±0.5		
Cooling capacity kW	+20 °C	+10 °C	0 °C
	4	3.4	2.4
	-5 °C	-10 °C	-20 °C
	1.95	1.5	0.65
Pump capacity	l/min	40	
Flow rate / Pressure	bar	0.5 - 3	
Filling volume liters	24 ... 30		
Dimensions cm	W × L × H 60 × 76 × 115		



FL4006

Order No.	9 666 040		
Model	FL4006		
Working temperature range °C	-20 ... +40		
Temperature stability °C	±0.5		
Cooling capacity kW	+20 °C	+10 °C	0 °C
	4	2.9	1.9
	-5 °C	-10 °C	-20 °C
	1.40	0.9	0.05
Pump capacity	l/min	60	
Flow rate / Pressure	bar	0.5 - 6	
Filling volume liters	24 ... 30		
Dimensions cm	W × L × H 60 × 76 × 115		

FL Recirculating Coolers

very powerful units, up to 20 kW of cooling capacity

The powerful FL models are suitable for a wide range of cooling tasks in industrial environments, such as removal of large process heat. 2 variants: Air-cooled (FL) and water-cooled (FLW).

- High cooling capacity of up to 20 kW
- Powerful circulating pumps
- Large power reserves with all applications
- Early warning function when condenser is dirty
- Low water consumption (on FLW models)
- Overload protection for pump motor and cooling machine
- Stainless steel bath tank
- BlackBox function with error memory for remote diagnosis
- Stakei connection for connecting a solenoid valve or a booster pump

Included in delivery: 2 Barbed fittings for tubing 1" ID
(pump connections G 1¼" male)

Pump capacity
Bath fluid: water

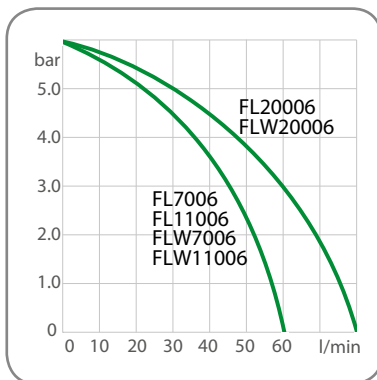

Rollers
add flexibility



Drain tap located behind
removable venting grid

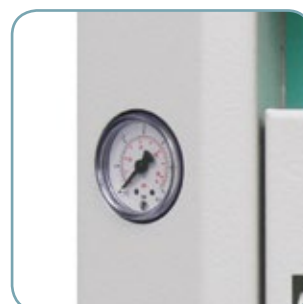

Pump pressure indicator for
models from FL1201



Pump pressure adjustable
for models from 3 bar



FLW7006

Order No.	9 676 070		
Model	FLW7006		
Working temperature range °C	-20 ... +40		
Temperature stability °C	±0.5		
Cooling capacity kW	+20 °C	+10 °C	0 °C
	7.4	7	5.5
	-5 °C	-10 °C	-20 °C
	4.30	3.1	1.3
Pump capacity	l/min	60	
Flow rate / Pressure	bar	0.5 - 6	
Filling volume liters	39 ... 47		
Dimensions cm	W × L × H		
	78 × 85 × 148		



FLW11006

Order No.	9 676 110		
Model	FLW11006		
Working temperature range °C	-20 ... +40		
Temperature stability °C	±0.5		
Cooling capacity kW	+20 °C	+10 °C	0 °C
	11.5	9	7.3
	-5 °C	-10 °C	-20 °C
	6.05	4.8	2.7
Pump capacity	l/min	60	
Flow rate / Pressure	bar	0.5 - 6	
Filling volume liters	39 ... 47		
Dimensions cm	W × L × H		
	78 × 85 × 148		



FLW20006

Order No.	9 676 200		
Model	FLW20006		
Working temperature range °C	-25 ... +40		
Temperature stability °C	±0.5		
Cooling capacity kW	+20 °C	+10 °C	0 °C
	20	15	12
	-5 °C	-10 °C	-20 °C
	9.50	7	3
Pump capacity	l/min	80	
Flow rate / Pressure	bar	0.8 - 6	
Filling volume liters	15 ... 37		
Dimensions cm	W × L × H		
	95 × 115 × 161		



FL7006

Order No.	9 666 070		
Model	FL7006		
Working temperature range °C	-20 ... +40		
Temperature stability °C	±0.5		
Cooling capacity kW	+20 °C	+10 °C	0 °C
	7	6.4	5.1
	-5 °C	-10 °C	-20 °C
	4.05	3	1.55
Pump capacity	l/min	60	
Flow rate / Pressure	bar	0.5 - 6	
Filling volume liters	39 ... 47		
Dimensions cm	W × L × H		
	78 × 85 × 148		



FL11006

Order No.	9 666 110		
Model	FL11006		
Working temperature range °C	-20 ... +40		
Temperature stability °C	±0.5		
Cooling capacity kW	+20 °C	+10 °C	0 °C
	11	9	7.5
	-5 °C	-10 °C	-20 °C
	6.25	5	3
Pump capacity	l/min	60	
Flow rate / Pressure	bar	0.5 - 6	
Filling volume liters	39 ... 47		
Dimensions cm	W × L × H		
	78 × 85 × 148		



FL20006

Order No.	9 666 200		
Model	FL20006		
Working temperature range °C	-25 ... +40		
Temperature stability °C	±0.5		
Cooling capacity kW	+20 °C	+10 °C	0 °C
	20	15	10
	-5 °C	-10 °C	-20 °C
	8	6	2.5
Pump capacity	l/min	80	
Flow rate / Pressure	bar	0.8 - 6	
Filling volume liters	15 ... 37		
Dimensions cm	W × L × H		
	95 × 115 × 161		

FC Recirculating Coolers

for heating and cooling tasks

FC models offer high temperature stability and feature integrated heating in addition.

2 variants: Air-cooled (FC) and water-cooled (FCW).

- Extended working temperatures up to +80 °C
- Two LED displays
- Adjustable feed/return temperature ratio
- Filling level indicator

Pump capacity

Bath fluid: water

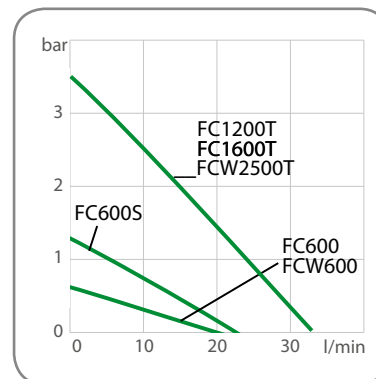

What cooling capacity do you need for your application?

The JULABO temperature control specialists can already calculate an ideal cooling capacity for you based on little data. JULABO merely needs three values, which you can determine easily for your application in most cases:

- | 1
Temperature of the cooling water prior to entering the application
- | 2
Temperature of the cooling water after exiting the application
- | 3
Cooling water flow rate in liters per minute

Send these three values to info.de@julabo.com. You will promptly receive a recommendation regarding the most suitable JULABO recirculating cooler.





FCW600

Order No.	9 601 060		
Model	FCW600		
Working temperature range °C	-20 ... +80		
Temperature stability °C	±0.2		
Heating capacity kW	1.2		
Cooling capacity kW	+20 °C	+10 °C	+5 °C
	0.6	0.47	0.4
	0 °C	-10 °C	-20 °C
	0.34	0.21	-
Pump capacity	l/min	20	
Flow rate / Pressure	bar	0.5	
Filling volume liters	6 ... 8		
Dimensions cm	W × L × H 35 × 54 × 49		



FCW600S

Order No.	9 601 063		
Model	FCW600S		
Working temperature range °C	-10 ... +80		
Temperature stability °C	±0.2		
Heating capacity kW	1.2		
Cooling capacity kW	+20 °C	+10 °C	+5 °C
	0.5	0.37	0.3
	0 °C	-10 °C	-20 °C
	0.235	0.1	-
Pump capacity	l/min	22	
Flow rate / Pressure	bar	1.2	
Filling volume liters	6 ... 8		
Dimensions cm	W × L × H 35 × 54 × 49		



FC600

Order No.	9 600 060		
Model	FC600		
Working temperature range °C	-20 ... +80		
Temperature stability °C	±0.2		
Heating capacity kW	1.2		
Cooling capacity kW	+20 °C	+10 °C	+5 °C
	0.6	0.47	0.4
	0 °C	-10 °C	-20 °C
	0.34	0.21	-
Pump capacity	l/min	20	
Flow rate / Pressure	bar	0.5	
Filling volume liters	6 ... 8		
Dimensions cm	W × L × H 35 × 54 × 49		



FC600S

Order No.	9 600 063		
Model	FC600S		
Working temperature range °C	-10 ... +80		
Temperature stability °C	±0.2		
Heating capacity kW	1.2		
Cooling capacity kW	+20 °C	+10 °C	+5 °C
	0.5	0.37	0.3
	0 °C	-10 °C	-20 °C
	0.235	0.1	-
Pump capacity	l/min	22	
Flow rate / Pressure	bar	1.2	
Filling volume liters	6 ... 8		
Dimensions cm	W × L × H 35 × 54 × 49		

Included in delivery: 2 barbed fittings each for tubing 8 and 12 mm inner dia. (pump connections M16x1 male)

FC Recirculating Coolers

for heating and cooling tasks

FC models offer high temperature stability and feature integrated heating in addition.

2 variants: Air-cooled (FC) and water-cooled (FCW).

- Models starting from a cooling capacity of 1.1 kW at +20 °C
- Heating capacity 1.2 kW

Models FC1200T, FC1600T, FCW2500T

External Pt100 sensor connection
Analog connections for external programming
and temperature recorder

Pump capacity

Bath fluid: water

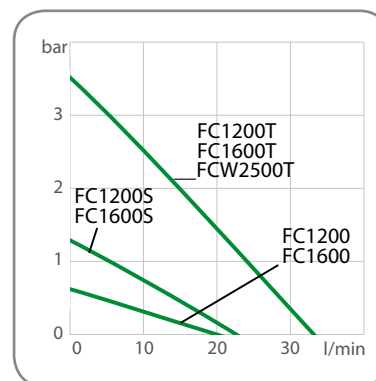

Included in delivery: 2 barbed fittings each for tubing 8 and 12 mm ID (pump connections M16x1 male)



FC1200

Order No.	9 600 120		
Model	FC1200		
Working temperature range °C	-20 ... +80		
Temperature stability °C	±0.2		
Heating capacity kW	1.2		
Cooling capacity kW	+20 °C	+10 °C	+5 °C
	1.3	0.95	0.75
	0 °C	-10 °C	-20 °C
	0.66	0.37	-
Pump capacity	l/min	20	
Flow rate / Pressure	bar	0.5	
Filling volume liters	8 ... 11		
Dimensions cm	W × L × H 46 × 61 × 49		



FC1200S

Order No.	9 600 123		
Model	FC1200S		
Working temperature range °C	-15 ... +80		
Temperature stability °C	±0.2		
Heating capacity kW	1.2		
Cooling capacity kW	+20 °C	+10 °C	+5 °C
	1.2	0.85	0.65
	0 °C	-10 °C	-20 °C
	0.555	0.26	-
Pump capacity	l/min	22	
Flow rate / Pressure	bar	1.2	
Filling volume liters	8 ... 11		
Dimensions cm	W × L × H 46 × 61 × 49		



FC1200T

Order No.	9 600 126		
Model	FC1200T		
Working temperature range °C	-10 ... +80		
Temperature stability °C	±0.2		
Heating capacity kW	1.2		
Cooling capacity kW	+20 °C	+10 °C	+5 °C
	1.1	0.75	0.55
	0 °C	-10 °C	-20 °C
	0.45	0.15	-
Pump capacity	l/min	28	
Flow rate / Pressure	bar	3.5	
Filling volume liters	8 ... 11		
Dimensions cm	W × L × H 46 × 61 × 49		

Digital/analog connections

- ① RS232 interface
- ② Standby input
- ③ Alarm output

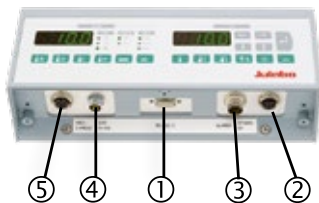

FC1200T, FC1600T, FCW2500T offer in addition:

- ④ External Pt100 sensor
- ⑤ External programming, Temperature recorder



FCW2500T

Order No.	9 601 256		
Model	FCW2500T		
Working temperature range °C	-25 ... +80		
Temperature stability °C	±0.2		
Heating capacity kW	1.2		
Cooling capacity kW	+20 °C	+10 °C	+5 °C
	2.5	2	1.8
	0 °C	-10 °C	-20 °C
	1.4	0.8	0.25
Pump capacity	l/min	28	
Flow rate / Pressure	bar	3.5	
Filling volume liters	8 ... 11		
Dimensions cm	W × L × H		
	46 × 61 × 49		



FC1600

Order No.	9 600 160		
Model	FC1600		
Working temperature range °C	-20 ... +80		
Temperature stability °C	±0.2		
Heating capacity kW	1.2		
Cooling capacity kW	+20 °C	+10 °C	+5 °C
	1.65	1.25	1
	0 °C	-10 °C	-20 °C
	0.86	0.47	-
Pump capacity	l/min	20	
Flow rate / Pressure	bar	0.5	
Filling volume liters	8 ... 11		
Dimensions cm	W × L × H		
	46 × 61 × 49		



FC1600S

Order No.	9 600 163		
Model	FC1600S		
Working temperature range °C	-15 ... +80		
Temperature stability °C	±0.2		
Heating capacity kW	1.2		
Cooling capacity kW	+20 °C	+10 °C	+5 °C
	1.55	1.15	0.9
	0 °C	-10 °C	-20 °C
	0.755	0.36	-
Pump capacity	l/min	22	
Flow rate / Pressure	bar	1.2	
Filling volume liters	8 ... 11		
Dimensions cm	W × L × H		
	46 × 61 × 49		



FC1600T

Order No.	9 600 166		
Model	FC1600T		
Working temperature range °C	-15 ... +80		
Temperature stability °C	±0.2		
Heating capacity kW	1.2		
Cooling capacity kW	+20 °C	+10 °C	+5 °C
	1.45	1.05	0.8
	0 °C	-10 °C	-20 °C
	0.65	0.25	-
Pump capacity	l/min	28	
Flow rate / Pressure	bar	3.5	
Filling volume liters	8 ... 11		
Dimensions cm	W × L × H		
	46 × 61 × 49		

SemiChill Recirculating Coolers

for highest requirements in industrial environments

The SemiChill models are characterized by maximum reliability in continuous operation and under harsh environmental conditions. All parts in contact with the bath fluid are made of stainless steel or high grade plastic. The modular design permits custom configurations according to your requirements.

- Five basic models, individually configurable
- High cooling capacity and strong circulating pumps
- Optional with integrated heater with a heating capacity of up to 12 kW
- Seal-free immersion pumps, maintenance-free and electronically adjustable
- Pressure and filling level indicator
- Sealed filling port (70 mm Ø)
- Overload protection for pump motor and cooling machine
- Pump connections: NPT 3/4" male

Models with type designation

- "a" = air cooling
- "w" = water cooling

Applications

Semiconductor industry (etching processes, stainless steel chucks, PVD, sputtering, wet benches), packaging industry, plastics industry, metering and adhesive technology, jacketed reaction vessels, kilo labs, pilot plants



SC2500a

Order No.	Order index on page 21		
Model	SC2500a		
Working temperature range °C ¹⁾	-20 ... +80		
Temperature stability °C	±0.1		
Cooling capacity kW	+20 °C 2.5	0 °C 1.5	-10 °C 0.9
Pump capacity	l/min	Order index on page 21	
Flow rate / Pressure	bar		
Filling volume liters	21 ... 33		
Dimensions cm	W × L × H 49 × 62 × 105		



SC2500w

Order No.	Order index on page 21		
Model	SC2500w		
Working temperature range °C ¹⁾	-20 ... +80		
Temperature stability °C	±0.1		
Cooling capacity kW	+20 °C 2.5	0 °C 1.5	-10 °C 0.9
Pump capacity	l/min	Order index on page 21	
Flow rate / Pressure	bar		
Filling volume liters	21 ... 33		
Dimensions cm	W × L × H 49 × 62 × 105		

¹⁾ Maximum working temperature range (standard working temperature range +5 ... +35 °C)

Pump capacity P3

Bath fluid: water

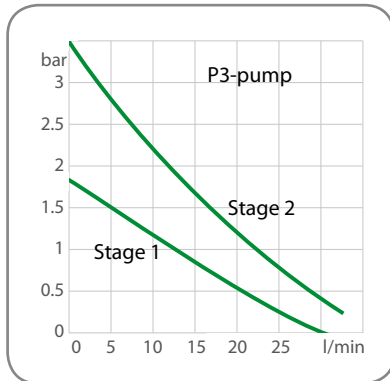

Pump capacity P4

Bath fluid: water

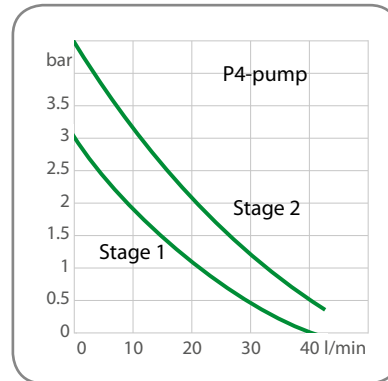

SC5000a

Order No. Order index on page 21

Model SC5000a

Working temperature range °C ¹⁾ -20 ... +130

Temperature stability °C ±0.1

Cooling capacity kW **+20 °C** 5.0 **0 °C** 2.5 **-10 °C** 1.2

Pump capacity l/min Order index on page 21
Flow rate / Pressure bar

Filling volume liters 43 ... 60

Dimensions cm W × L × H
59 × 67 × 112



SC5000w

Order No. Order index on page 21

Model SC5000w

Working temperature range °C ¹⁾ -20 ... +130

Temperature stability °C ±0.1

Cooling capacity kW **+20 °C** 5.0 **0 °C** 2.5 **-10 °C** 1.2

Pump capacity l/min Order index on page 21
Flow rate / Pressure bar

Filling volume liters 43 ... 60

Dimensions cm W × L × H
59 × 67 × 112



SC10000w

Order No. Order index on page 21

Model SC10000w

Working temperature range °C ¹⁾ -20 ... +130

Temperature stability °C ±0.1

Cooling capacity kW **+20 °C** 10.0 **0 °C** 5.0 **-10 °C** 2.5

Pump capacity l/min Order index on page 21
Flow rate / Pressure bar

Filling volume liters 43 ... 60

Dimensions cm W × L × H
59 × 67 × 112

Operating and control electronics

Equipment features

Eco

Professional



Multi-Display (LED) temperature display	•	
VFD Comfort display with simultaneous display of 3 values		•
Keypad, splash-proof	•	•
PID temperature control	•	•
3-point calibration	•	•
Pump capacity adjustable in stages	•	•
RS232 interface	•	•
Stakei connections for power supply (e.g. shut-off valve)	•	•
Early warning system for low level, high and low temperature limits	•	•
High-temperature cut-off adjustable via display	•	•
Low liquid level protection with cut-off function	•	•
Classification III (DIN 12876-1)	•	•
Remote diagnosis function via integrated <i>BlackBox</i>	•	•
Connector for external Pt100 sensor for measuring and controlling the external system		•
Integrated programmer with real time clock for 1x10 program steps		•
Quantitative conductivity measurement and display, range 0.5...5 Ω/cm		•
Flow measurement and status display (pre-set limit value)*		•
Options for <i>Professional</i> electronics		
Freely scalable analog interfaces (E-PROG input, standby input, alarm output)	--	Optional
RS485 interface	--	Optional

**Professional* electronics with analog connections required. Flow sensor not included.

Further options for working temperature, pump capacity, and heating

Model	Working temperature range				Circulating pumps		Heaters			
	Standard	Low temp	Low/high temp I	Low/high temp II	P3	P4	H0	H1	H5	H12
	+5 °C ... +35 °C	-20 °C ... +35 °C	-20 °C ... +80 °C	-20 °C ... +130 °C	33 l/min 3.5 bar	43 l/min 4.3 bar	no heater	1 kW	5 kW	12 kW
SC2500a SC2500w	✓	Optional	Optional	--	✓	--	✓	Optional	--	--
SC5000a SC5000w SC10000w	✓	Optional	Optional	Optional	✓	Optional ¹⁾	✓	--	Optional	Optional

✓ This feature is already included with the basic model ¹⁾ Cooling capacity reduced by 0.2 kW

Filter housings

Please specify the desired filter option when ordering. Retrofitting is not possible. Housing is mounted on the right side of the unit.

- D1** DI-filter housing, plastic (up to +35 °C), incl. cartridge
- D2** DI-filter housing, stainless steel (up to +90 °C), incl. cartridge
- M1** Micro-filter housing, plastic (up to +35 °C), w/o cartridge
- M2** Micro-filter housing, stainless steel (up to +130 °C), w/o cartridge

Filter housings for DI-filter and micro-filter (optional)



Order index

for your custom unit configuration

Combine one of the five basic models with options of your choice. Please use the order index shown below to create the order number for your unit. The following example is for model SC5000a:

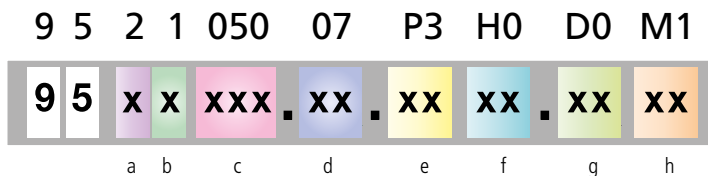

Custom unit configuration

- > Control electronics
- > Pump capacity
- > Working temperature
- > Interfaces
- > Heating capacity
- > Filter housings



Keypad and control electronics

- 0 Eco
- 2 Professional
- 3 Professional with analog interface module
- 7 Professional with RS485 interface



Working temperature range

- 0 Standard (+5 ... +35 °C)
- 1 LowTemp (-20 ... +35 °C)
- 2 Low/HighTemp I (-20 ... +80 °C)
- 3 Low/HighTemp II (-20 ... +130 °C)



Basic model

- 025 SC2500a
- 026 SC2500w
- 050 SC5000a
- 051 SC5000w
- 101 SC10000w



Voltage version¹⁾

- 03 230 V / 50 Hz
- 07 400 V (3 Ph.) / 50 Hz
- 13 208-230 V / 60 Hz
- 16 208-230 V (3 Ph.) / 60 Hz



Circulating pump (pump type, pump capacity)

- P3 33 l/min. - 3.5 bar max.
- P4 43 l/min. - 4.3 bar max.



Integrated heater

- H0 Without heater
- H1 Heating capacity 1 kW
- H5 Heating capacity 5 kW
- H12 Heating capacity 12 kW



DI-filter housing

- D0 Without DI-filter housing
- D1 DI-filter housing, plastic (up to +35 °C max.)
- D2 DI-filter housing, stainless steel (up to +90 °C max.)



Micro-filter housing

- M0 Without micro-filter housing
- M1 Micro-filter housing, plastic (up to +35 °C max.)
- M2 Micro-filter housing, stainless steel (up to +130 °C max.)

¹⁾ Voltage version

SC2500a, SC2500w	SC5000a, SC5000w, SC10000w
230 V / 50 Hz or	400 V (3 ph.) / 50 Hz or
208-230 V / 60 Hz	208-230 V (3 ph.) / 60 Hz

Accessories

JULABO Thermal Bath Fluids

JULABO Thermal bath fluids have been carefully chosen after long-term testing. They are ideally suited for all of your temperature control applications guaranteeing safe and reliable operation.

Choosing the proper bath fluid is critical for the results in temperature control. The viscosity, oxidation and heat transfer characteristics of the Thermal fluids are specifically matched with each JULABO temperature control instrument.

Advantages

- Wide temperature ranges
- Low viscosity
- High stability
- Good heat conductivity
- Minimum odor
- Low corrosion tendency
- Low toxicity
- Long shelf life



Working temperature range

Extended temperature range Thermal H10

Working temperature ranges

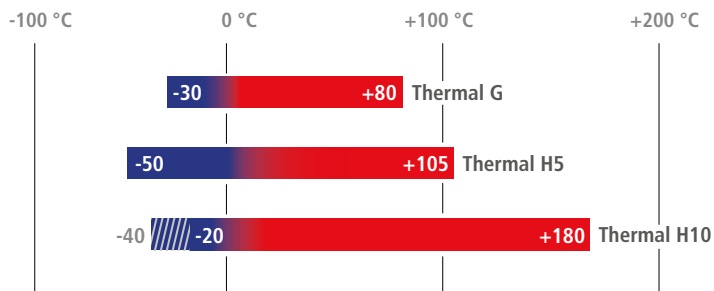

Makes routine laboratory work easier.

JULABO Thermal bath fluids are delivered in containers with a handy drain tap.



Thermal G

Order No. 5 liters 8 940 125

Order No. 10 liters 8 940 124

Working temperature range °C -30 ... +80

Flash point °C not applicable

Fire point °C not applicable

Viscosity, (kinematic at +20 °C) mm²/s 4.07

Density (at +20 °C) g/cm³ 1.08

Pour point °C -70

Boiling point °C +108

Ignition temperature °C +430

Color light yellow

Thermal H5

Order No. 5 liters 8 940 107

Order No. 10 liters 8 940 106

Working temperature range °C -50 ... +105

Flash point °C +124

Fire point °C +142

Viscosity, (kinematic at +20 °C) mm²/s 5.66

Density (at +20 °C) g/cm³ 0.92

Pour point °C -100

Boiling point °C +288

Ignition temperature °C +350

Color clear

Thermal H10

Order No. 5 liters 8 940 115

Order No. 10 liters 8 940 114

Working temperature range °C (-40) -20 ... +180

Flash point °C >+170

Fire point °C +220

Viscosity, (kinematic at +20 °C) mm²/s 10.8

Density (at +20 °C) g/cm³ 0.94

Pour point °C <-60

Boiling point °C +288

Ignition temperature °C +370

Color clear

JULABO Thermal bath fluids based on silicon ...

... are chemically inert substances which do not affect metals like iron, copper, zinc, aluminum, chrome or nickel. Compared to other fluids, JULABO Thermal fluids have an extraordinarily high dielectric strength. When properly stored, the fluids will last for 12 months and longer as they are not susceptible to climatic influences.

JULABO Thermal bath fluids based on water-glycol ...

... (monoethyleneglycol with anti-corrosion additives) have excellent thermal characteristics and a low viscosity. In addition, they provide anti-freeze protection, i.e. they can be applied at temperatures below the freezing point of water.

More information on JULABO Thermal bath fluids ...

... in our brochure 'The Thermal Bath Fluids' at www.julabo.com.



Accessories



CR® tubing

Order No.	Description	Suitable for
8 930 008	1 m CR® tubing, 8 mm ID (-30 °C ... +120 °C)	AWC100, F250, FL300
8 930 010	1 m CR® tubing, 10 mm ID (-30 °C ... +120 °C)	AWC100, F250
8 930 012	1 m CR® tubing, 12 mm ID (-30 °C ... +120 °C)	FL300



Reinforced tubing

Order No.	Description	Suitable for
8 930 308	1 m reinforced tubing, 8 mm ID, pressure resistant (-40 °C ... +120 °C)	F500, F1000, FL601/1201/1701, FC models
8 930 312	1 m reinforced tubing, 12 mm / ½" ID, pressure resistant (-40 °C ... +120 °C)	F500, F1000, FL601/1201/1701, FC models
8 930 319	1 m reinforced tubing, ¾" ID, pressure resistant (-40 °C ... +120 °C)	FL(W)1203/1703/2503/4003
8 930 325	1 m reinforced tubing, 1" ID, pressure resistant (-40 °C ... +120 °C)	FL(W)2506/4006/7006/11006/20006



Tubing insulation

Order No.	Description	Suitable for
8 930 410	1 m insulation, 14 mm ID	CR® tubing 8 to 10 mm ID
8 930 412	1 m insulation, 18 mm ID	CR® tubing 12 mm ID, Reinforced tubing 8 mm ID
8 930 413	1 m insulation, 23 mm ID	Reinforced tubing 12 mm / ½" ID
8 930 419	1 m insulation, 29 mm ID	Reinforced tubing ¾" ID
8 930 425	1 m insulation, 35 mm ID	Reinforced tubing 1" ID



Tube clamps

Order No.	Description	Suitable for
8 970 480	2 Tube clamps, size 1	CR® tubing, 8 mm ID
8 970 481	2 Tube clamps, size 2	CR® tubing 10/12 mm ID, Reinforced tubing 8 mm ID
8 970 482	2 Tube clamps, size 3	Reinforced tubing 12 mm / ½" ID
8 970 483	2 Tube clamps, size 4	Reinforced tubing ¾" ID
8 970 484	2 Tube clamps, size 5	Reinforced tubing 1" ID



Twin and quad distributing adapters

Order No.	Description	Suitable for
8 970 470	Twin distributing adapter with barbed fittings for tubing 8 mm ID	F, FL, FC
8 970 472	Twin distributing adapter with barbed fittings for tubing 10 mm ID	F, FL, FC
8 970 471	Twin distributing adapter with barbed fittings for tubing 12 mm ID	F, FL, FC
8 970 476	Twin distributing adapter G ¾" with barbed fittings for tubing ¾" ID	FL(W)1203/1703/2503/4003
8 970 477	Twin distributing adapter G 1¼" with barbed fittings for tubing 1" ID	FL(W)2506/4006/7006/11006/20006
8 970 474	Quad distributing adapter (2 pieces), M16x1, with barbed fittings for tubing 8 mm or 12 mm / ½" ID	FC
8 970 520	Quad distributing adapter (2 pieces), M16x1, with barbed fittings for tubing 8 mm or 12 mm / ½" ID	F500, F1000, FL(W)601/1201/1701

Order No.	Description	Suitable for
8 970 522	Quad distributing adapter (2 pieces), G 3/4" female, with barbed fittings for tubing 3/4" ID	FL(W)1203/1703/2503/4003
8 970 524	Quad distributing adapter (2 pieces), G 1 1/4" female, with barbed fittings for tubing 1" ID	FL(W)2506/4006/7006/11006/20006

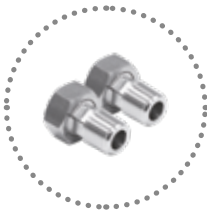

Connections/Adapters

Order No.	Description	Suitable for
8 890 036	2 Barbed fittings for tubing 1/2" ID to NPT 3/4" female	SemiChill
8 890 037	2 Barbed fittings for tubing 5/8" ID to NPT 3/4" female	SemiChill
8 890 038	2 Adapters NPT 3/4" female to M16x1 male	SemiChill
8 890 040	2 Adapters G 3/4" female to M16x1 male	FL(W)1203/1703/2503/4003
8 890 041	2 Adapters G 1 1/4" female to M16x1 male	FL(W)2506/4006/7006/11006/20006
8 890 042	2 Adapters G 3/4" female to barbed fitting for tubing 1/2" ID	FL(W)1203/1703/2503/4003
8 890 043	2 Adapters G 3/4" female to barbed fitting for tubing 3/4" ID	FL(W)1203/1703/2503/4003
8 890 044	2 Adapters G 1 1/4" female to barbed fitting for tubing 1/2" ID	FL(W)2506/4006/7006/11006/20006
8 890 045	2 Adapters G 1 1/4" female to barbed fitting for tubing 3/4" ID	FL(W)2506/4006/7006/11006/20006
8 890 046	2 Adapters G 1 1/4" female to barbed fitting for tubing 1" ID	FL(W)2506/4006/7006/11006/20006
8 890 047	2 Adapters G 3/4" female to NPT 1/2" male	FL(W)1203/1703/2503/4003
8 890 048	2 Adapters G 3/4" female to NPT 3/4" male	FL(W)1203/1703/2503/4003
8 890 049	2 Adapters G 1 1/4" female to NPT 1/2" male	FL(W)2506/4006/7006/11006/20006
8 890 050	2 Adapters G 1 1/4" female to NPT 3/4" male	FL(W)2506/4006/7006/11006/20006
8 890 051	2 Adapters G 1 1/4" female to NPT 1" male	FL(W)2506/4006/7006/11006/20006

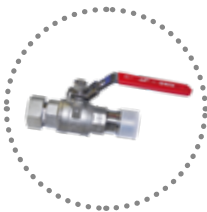

Particle filters / Shut-off valves / Solenoid valve / Castor platform

Order No.	Description	Suitable for
8 970 905	Air filter	AWC100
8 970 906	Filter cartridge	AWC100
8 920 000	Particle filter for cooling water circuit (for water-cooled models)	FLW, FCW, SC5000w, SC10000w
8 970 456	Shut-off valve for loop circuit M16x1	F500, F1000, FL300/601/1201/1701, FC, FCW
8 970 454	Shut-off valve G 3/4"	FL(W)1203/1703/2503/4003
8 970 458	Shut-off valve G 1 1/4"	FL(W)2506/4006/7006/11006/20006
8 980 701	Solenoid valve set for loop circuit (-10 °C ... +130 °C), M16x1	FC, FCW
8 910 045	Castor platform	F250
8 920 016	Micro-filter cartridge 10 micron	SemiChill with option M1
8 920 017	Micro-filter cartridge 25 micron	SemiChill with option M1
8 920 018	Micro-filter cartridge 40 micron	SemiChill with option M1
8 920 019	Micro-filter cartridge 100 micron	SemiChill with option M1
8 920 020	Micro-filter cartridge 250 micron	SemiChill with option M1
8 920 036	Micro-filter cartridge 10 micron	SemiChill with option M2
8 920 038	Micro-filter cartridge 40 micron	SemiChill with option M2
8 920 039	Micro-filter cartridge 100 micron	SemiChill with option M2
8 920 040	Micro-filter cartridge 250 micron	SemiChill with option M2
8 920 005	DI filter cartridge	DI-filter housing, plastic/stainless steel D1/D2
8 920 100	Drain tap, stainless steel, to empty bath easily	SemiChill
8 980 705	Solenoid valve set, 230 V/50-60 Hz, -10 ... +130 °C (Included in delivery: 1 solenoid valve and 1 back pressure valve)	SemiChill



External Pt100 sensors and extension cables

Order No.	Description	Suitable for
8 981 003	200 × 6 mm Ø, stainless steel, 1.5 m cable	FC-T variant, SemiChill with professional electronics
8 981 006	20 × 2 mm Ø, stainless steel, 1.5 m cable	FC-T variant, SemiChill with professional electronics
8 981 010	300 × 6 mm Ø, stainless steel, 1.5 m cable	FC-T variant, SemiChill with professional electronics
8 981 017	200 × 6 mm Ø, stainless steel/PTFE coated, 3 m cable	FC-T variant, SemiChill with professional electronics
8 981 015	300 × 6 mm Ø, stainless steel/PTFE coated, 3 m cable	FC-T variant, SemiChill with professional electronics
8 981 013	600 × 6 mm Ø, stainless steel/PTFE coated, 3 m cable	FC-T variant, SemiChill with professional electronics
8 981 016	900 × 6 mm Ø, stainless steel/PTFE coated, 3 m cable	FC-T variant, SemiChill with professional electronics
8 981 014	1200 × 6 mm Ø, stainless steel/PTFE coated, 3 m cable	FC-T variant, SemiChill with professional electronics
8 981 020	M+R in-line Pt100 sensor, 2 connections M16x1 male	FC-T variant, SemiChill with professional electronics
8 981 103	Extension cable 3.5 m for Pt100 sensor	FC-T variant, SemiChill with professional electronics



Connection plugs and converters

Order No.	Description	Suitable for
8 980 131	External Pt100 sensor connector	FC-T variant, SemiChill with professional electronics
8 980 133	Standby connector, 3 pin	FC, SemiChill with professional electronics
8 980 135	Alarm connector, 5 pin	FL, FC, SemiChill with professional electronics
8 980 136	REG+EPROG connector, 6 pin	FC-T variant, SemiChill with professional electronics
8 980 137	Stakei connector	FC, SemiChill, from FL 2503
8 980 024	SCB converter box	FC, SemiChill



Wireless communication & Software

Order No.	Description	Suitable for
8 900 020	Profibus DP interface	FL, FC, SemiChill
8 900 024	RS485 interface	FL, FC, SemiChill
8 900 110	USB interface adapter cable, 2.5 m	FL, FC, SemiChill
8 901 102	EasyTEMP Software (free of charge at www.julabo.com)	FL, FC, SemiChill
8 901 105	EasyTEMP Professional Software, incl. USB Dongle	FL, FC, SemiChill
8 980 031	Ethernet/RS232 interface converter	FL, FC, SemiChill
8 980 032	4-EtherNet/RS232 converter	FL, FC, SemiChill
8 980 033	8-EtherNet/RS232 converter	FL, FC, SemiChill
8 980 034	WLAN/RS232 converter	FL, FC, SemiChill
8 980 035	2 Channel WLAN/RS232 converter	FL, FC, SemiChill
8 980 036	ATEX Tablet Agile X	FL, FC, SemiChill
8 980 073	RS232 interface cable, 2.5 m	FL, FC, SemiChill
8 980 074	RS232 interface cable, 5 m	FL, FC, SemiChill



Calibration and testing certificates

Order No.	Description	Suitable for
8 902 901	1-Point Manufacturer's Calibration Certificate for JULABO circulators	All models except AWC100
8 902 903	3-Point Manufacturer's Calibration Certificate for JULABO circulators	All models except AWC100
8 902 905	5-Point Manufacturer's Calibration Certificate for JULABO circulators	All models except AWC100
8 903 025	Manufacturer's Testing Certificate for JULABO refrigeration units	All models except AWC100 up to 1 kW cooling capacity (at +20 °C)
8 903 035	Manufacturer's Testing Certificate for JULABO refrigeration units	All models except AWC100 starting from 1 kW cooling capacity (at +20 °C)



IQ/OQ Documentation

Order No.	Description	Suitable for
2 310 120	IQ/OQ Documentation, Category 2	F, FL, FC
2 310 130	IQ/OQ Documentation, Category 3	SemiChill



Preventative maintenance contracts

Order No.	Description	Suitable for
2 350 100	Preventative Maintenance Contract Standard includes the following services: Visual inspection, technical diagnostics, read-out of error memory (BlackBox), testing of tube connections and bath fluid, thorough cleaning of performance-reducing contaminations, testing of control behavior (temperature stability), sensor calibration as needed, testing/measuring of pump and cooling capacity (depending on model) and firmware update (if no hardware adjustment is required)	All models
2 350 110	Preventative Maintenance Contract Premium includes all services listed above as well as spare and wear parts and labor required for installation and replacement	All models

Booster Pump

The new JULABO magnetically coupled Booster Pump is the ideal solution to increase the pressure or flow rate in your application. The Booster Pump is specifically designed to be easily connected between various JULABO instruments and your application.

The Booster Pump can add 2.1 bar to your fluid pressure. The stainless steel design of the pump provides excellent resistivity against chemical effects. The pump design guarantees 100 % leakage free operation over an extraordinary temperature range of -90 °C ... +250 °C.

The Booster Pump is suitable for FC and SemiChill recirculating coolers*³⁾

Pump connector cable for connection of the SBC converter box is included in the delivery.

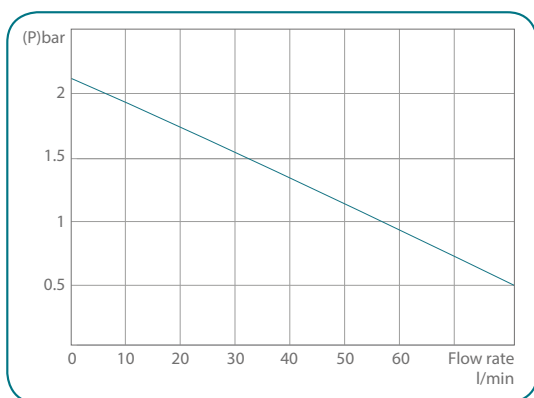

(Measured in a fluid with a density of 1 kg/dm³)

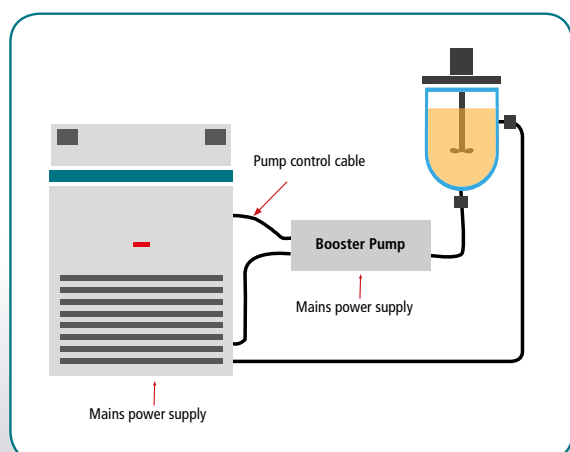

Booster Pump (Magnetically Coupled)

Order No.	8 810 020	
Model	Booster Pump	
Working temperature range °C	-90 ... 250	
Pump type	Centrifugal pump	
Material Pump / housing	Stainless steel	
Pump capacity	l/min	80
Flow rate / Pressure	bar	2.1 ^{*1)}
Pump pressure adjustment	Manual	
Pump pressure display	2 manometers, for input and output pressure	
Suitable fluids	Water-glycol, silicon oil, Fluorinert®	
Viscosity max. cSt.	50	
Fluid connectors	M30x1.5 male ^{*2)}	
Mains power supply	208 – 230V ±10 % / 50-60 Hz 1~	
Power consumption	1.85 A (208 V) / 2 A (230 V)	
Heat input W	230 at full motor speed	
Control input	3-pin connector for SCB converter box	
Weight kg	13.2	
Dimensions cm	W × L × H 28 × 42.5 × 24	

*¹⁾ In addition to the pump pressure of the suitable JULABO instrument.

*²⁾ Adapters may be required.

*³⁾ The JULABO SCB converter box (Order No. 8 980 024) is required.

Plate Heat Exchanger

Plate heat exchangers from JULABO are the ideal solution for applications, in which the bath fluid cannot be used directly in the temperature control instrument.

Depending on the application, this may be the case for example due to viscosity, pressure or material compatibility. In such situations, a plate heat exchanger ensures system separation between the temperature control instrument circuit and the application circuit, thus enabling the use of JULABO devices.

The heat exchangers are compact, professionally insulated and, thanks to our decades of experience, always optimally tailored to customer-specific requirements. This includes topics such as dimensioning, connections, performance characteristics or desired temperature control medium.

Application examples

- Temperature control of osmosis water in the temperature range of +4 °C to +84 °C.
- Cool-down and condensation of gases/vapors
- Cool-down of gear oil to temperatures down to -40 °C, following by maintenance of the required temperature after self-heating

